

INSTRUCTIONS ASSEMBLY SKI LIFT JC84391

REPLICA OF THE GENUINE MODEL OF DOPPELMAYR UNI GV STATION
 SCALE 1:32
 USE WITH ADAPTER 5V (EU: JC50080/ UK: JC50280/ USA: JC50180)
 OR BATTERIES 4 X AA 1.5V (BOTH NOT INCLUDED)

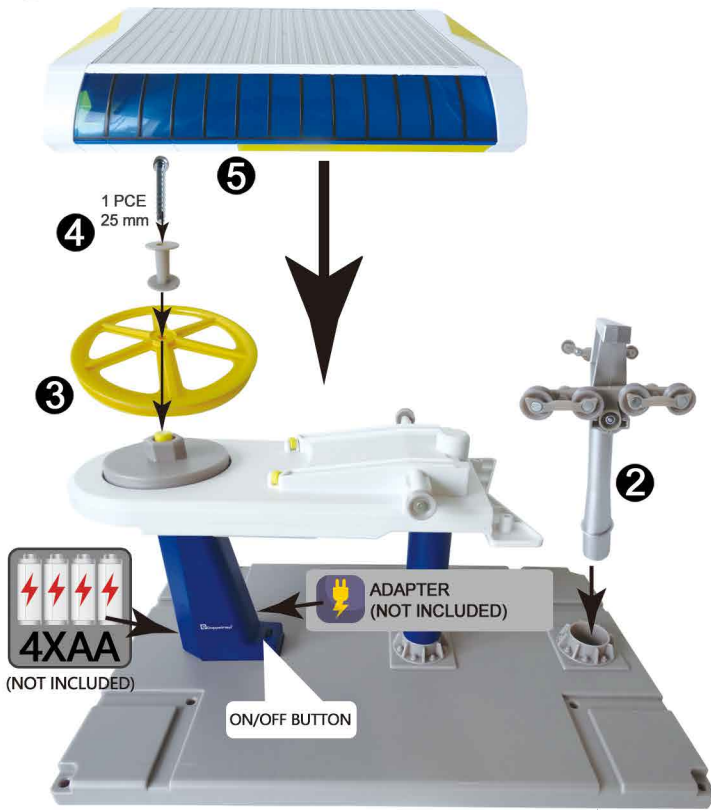

A ASSEMBLE BOTTOM STATION



B ASSEMBLE TOP STATION

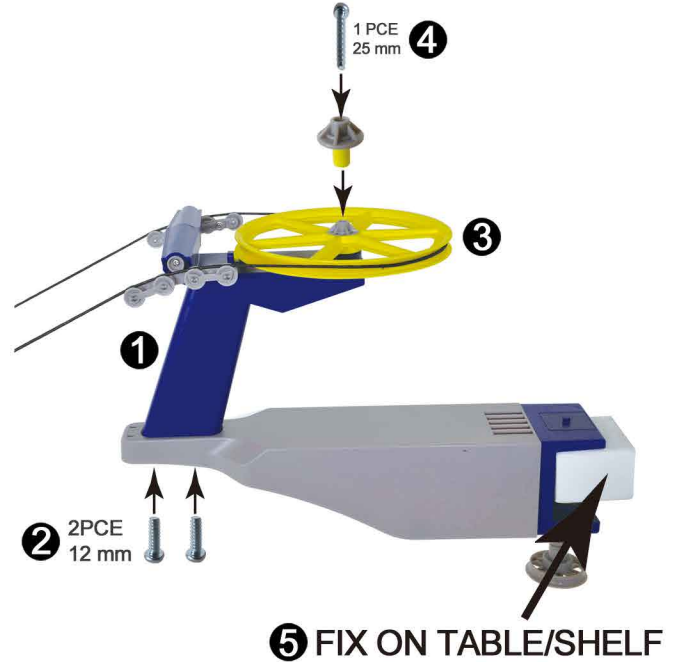

FIX BOTTOM STATION



C ATTACH THE CABLE AND ADD CABINS/SEATS

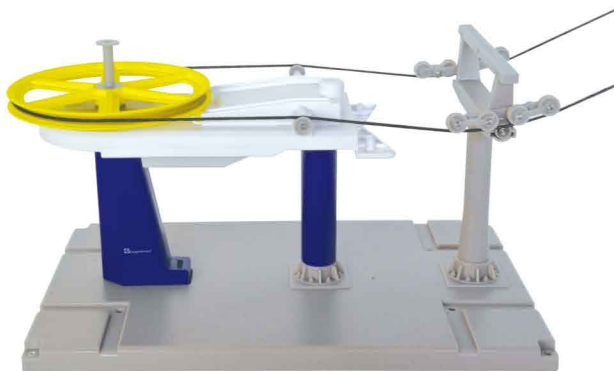

1 BOTTOM STATION

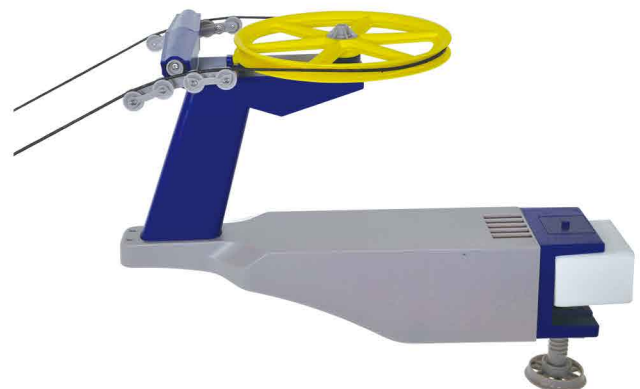

2 TOP STATION



3 CONNECT THE CABLE TIGHTLY, BUT NOT TOO TIGHT.



4 ATTACH CABINS/SEATS ANYWHERE ON THE CABLE.







D INSERT BATTERIES OR ATTACH ADAPTER, SWITCH ON THE "ON-BUTTON" AND ENJOY!



Die verpackung muss aufbewahrt werden, da diese wichtige Informationen enthält.
L'emballage doit être conservé, car il contient des informations importantes.
Non gettare la scatola in quanto contiene informazioni importanti.
Packaging has to be kept since it contains important information.
De verpakking bewaren, deze bevat belangrijke informatie.
We are unable to accept liability for any minor variations in colour or design that may occur.

WARNING:

-  Achtung. Nicht für Kinder unter 36 Monaten geeignet. Erstickungsgefahr. Dieses produkt enthält kleinteile.
-  Attention. Ne convient pas aux enfants de moins de 36 mois. Danger d'étouffement. Ce produit contient de petits éléments.
-  Avvertenza. Non adatto a bambini di età inferiore a 36 mesi. Rischio di soffocamento. Questo prodotto contiene piccolo parti.
-  Warning. Not suitable for children under 36 months. Choking hazard. Contains small parts.
-  Waarschuwing. Niet geschikt voor kinderen jonger dan 36 maanden. Verstikkingsgevaar. Bevat kleine onderdelen.

Insert and remove batteries in a correct way.
Non-rechargeable batteries are not to be recharged.
Rechargeable batteries are to be removed from the toy before being charged.
Rechargeable batteries are only to be charged under adult supervision.
Different types of batteries or new and used batteries are not to be mixed.
Batteries are to be inserted with correct polarity (+ & -)
Exhausted batteries are to be removed from the toy.
The supply terminals are not to be short-circuited.
Charge only by suitable charger which is included.
After playing, switch off and remove the battery.
Do not use near water or fire.
Do not put the batteries in water or fire.
Use only the recommended batteries 4 x AA 1.5 V or recommended adapter 5V
(EU: JC50080/ UK: JC50280/ USA: JC50180).



NOTICE D' ASSEMBLAGE TÉLÉFÉRIQUE JC84391

RÉPLIQUE DU MODÈLE D'ORIGINE DE LA STATION DOPPELMAYR UNI GV
ECHELLE 1:32
FONCTIONNE AVEC L' ADAPTATEUR 5V (EU: JC50080/ UK: JC50280/ USA: JC50180)
OU PILES 4 X AA 1.5V (LES DEUX NON INCLUS)



A Assemblez la base de la station

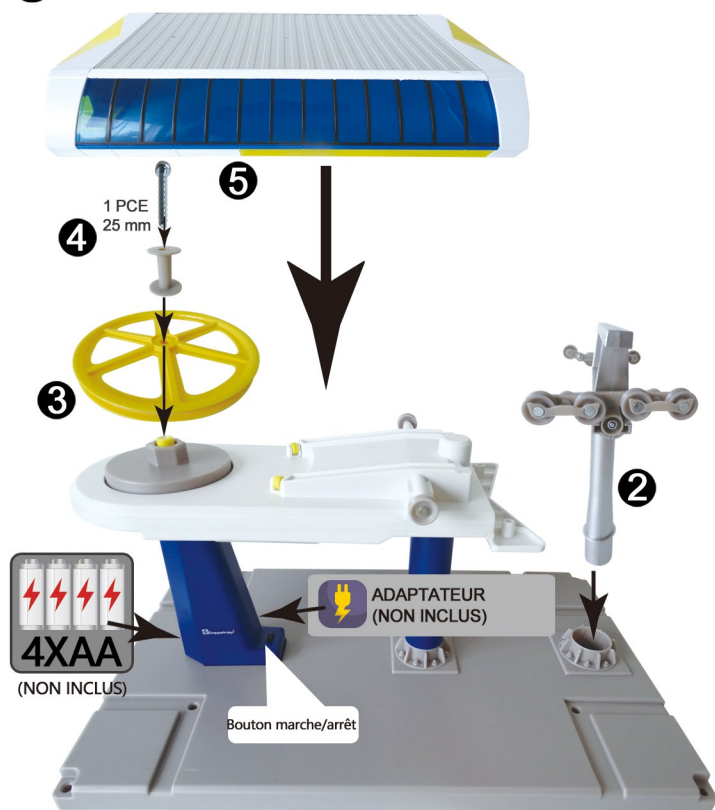

B Assemblez la haute station

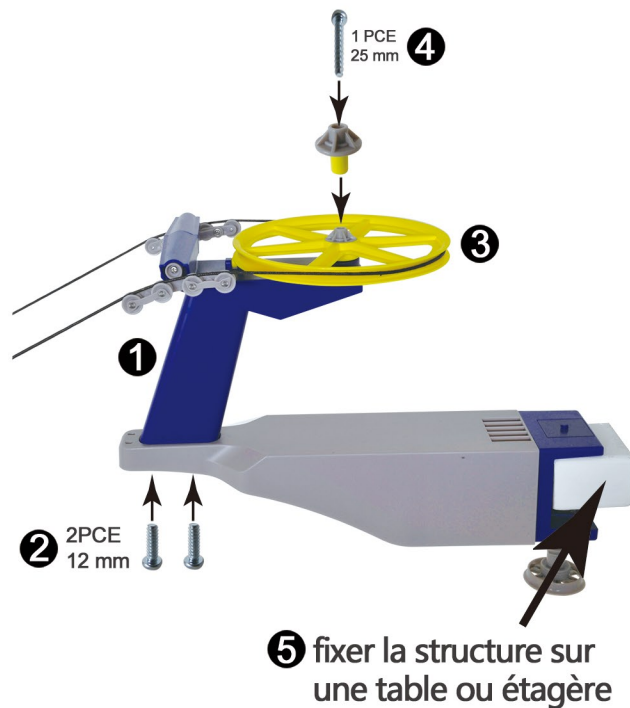

Fixer la base de la station

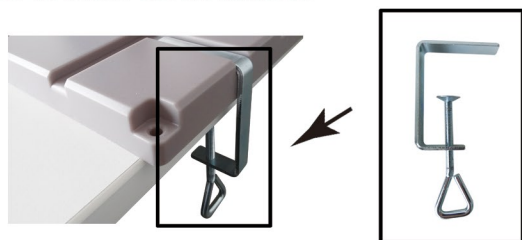

C Attacher le câble ensuite les cabines/Télesièges

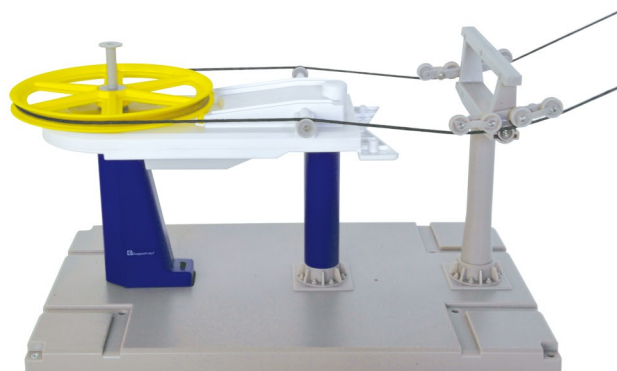

1 Base de la station

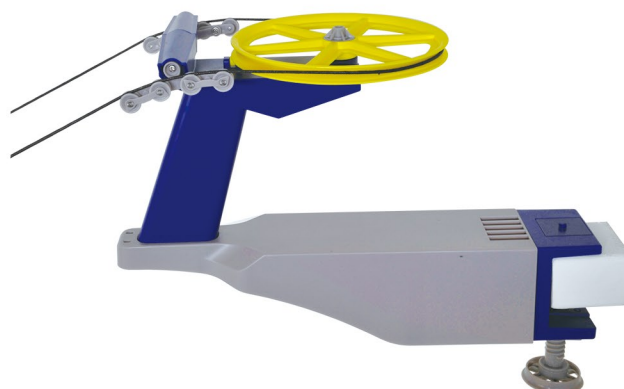

2 Haut de la station



3 Connecter et tendre le câble mais pas trop serrée



4 Attacher les cabines ou vous le désirez sur le câble tendu.







D Allumez le bouton 'ON' et c' est parti !



L'emballage doit être conservé, car il contient des informations importantes.

WARNING:

-  Achtung. Nicht für Kinder unter 36 Monaten geeignet. Erststüchungsgefahr. Dieses produkt enthält kleinteile.
-  Attention. Ne convient pas aux enfants de moins de 36 mois. Danger d'étouffement. Ce produit contient de petits éléments.
-  Avvertenza. Non adatto a bambini di età inferiore a 36 mesi. Rischio di soffocamento. Questo prodotto contiene piccolo parti.
-  Warning. Not suitable for children under 36 months. Choking hazard. Contains small parts.
-  Waarschuwing. Niet geschikt voor kinderen jonger dan 36 maanden. Verstikkingsgevaar. Bevat kleine onderdelen.

Insérez et retirez les piles dans le bon sens .
 Ne pas recharger des piles non rechargeables.
 Les piles rechargeables doivent être retirées du jouet avant d'être chargées.
 Les piles rechargeables ne doivent être chargées que sous la surveillance d'un adulte.
 Rechargeable batteries are only to be charged under adult supervision.
 Différents types de piles ou piles neuves et usagées ne doivent pas être mélangées
 Les piles doivent être insérées avec la polarité correcte (+ & -)
 Les piles épuisées doivent être retirées du jouet
 Les bornes d'alimentation ne doivent pas être court-circuitées.
 Chargez uniquement avec un chargeur approprié,
 Après avoir joué, éteignez et retirez la batterie.
 Ne pas utiliser près de l'eau ou du feu.
 Utilisez uniquement les piles recommandées 4 x AA 1.5 V ou l'adaptateur
 recommandé 5 V (EU: JC50080/ UK: JC50280/ USA: JC50180).